



**SERIES: 6 W WALL PLUG**

**DESCRIPTION: SWITCHING POWER SUPPLY**

**FEATURES**

- Level V (efficient design)
- 100 ~ 130 V ac input voltage
- regulated output voltage
- short circuit, over load protection
- meets EISA / efficiency level IV regulations
- custom designs available



MODEL	output voltage		output current		output wattage	ripple*	efficiency level	cord length (mm)
	nominal (V dc)		min (A)	max (A)	max (W)	max. (mVp-p)		
EPS030100	3		0	1	3	100	IV	1800 ±100
EPS033100	3.3		0	1	3.3	100	IV	1800 ±100
EPS036100	3.6		0	1	3.6	100	IV	1800 ±100
EPS045100	4.5		0	1	4.5	100	V	1800 ±100
EPS050100	5		0	1	5	100	V	1800 ±100
EPS060100	6		0	1	6	100	V	1800 ±100
EPS075080	7.5		0	0.8	6	100	V	1800 ±100
EPS090066	9		0	0.66	6	100	V	1800 ±100
EPS100060	10		0	0.6	6	100	V	1800 ±100
EPS120050	12		0	0.5	6	120	V	1800 ±100
EPS135044	13.5		0	0.44	6	135	V	1800 ±100
EPS150040	15		0	0.4	6	150	V	1800 ±100
EPS180033	18		0	0.33	6	180	V	1800 ±100
EPS240025	24		0	0.25	6	240	IV	1800 ±100

\*at full load, 100 ~ 130 V ac input, measured at 20MHz bandwidth with a 10 uF electrolytic cap and a 0.1 uF ceramic cap on the output

**PART NUMBER KEY**

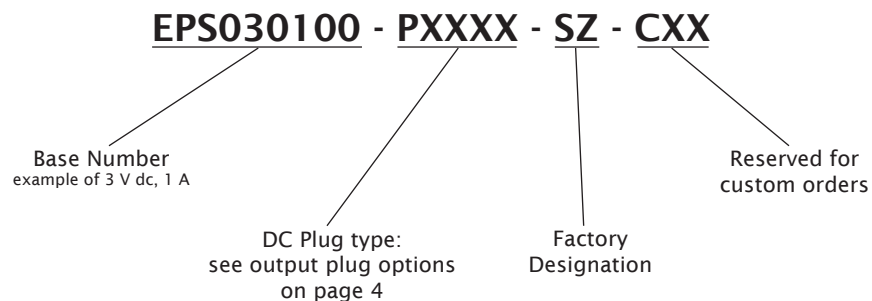



**SERIES: 6 W WALL PLUG**

**DESCRIPTION: SWITCHING POWER SUPPLY**

## INPUT

parameter	conditions/description	min	nom	max	units
rated input voltage		100	120	130	V ac
rated frequency		50		60	Hz
frequency range		47		63	Hz
inrush current	120 V ac, inrush lasts no longer than 0.5 ms before settling to steady state current			40	A
no load power consumption	Input: 100 ~ 120 V ac			0.5	W

## OUTPUT

parameter	conditions/description	min	nom	max	units
line regulation			±2		%
load regulation	full load to no load, > 5 V full load to no load, < 5 V	-5%	±5	+0.25 V	%
over/undershoot	at turn-on and turn-off		0		%
temp. coefficient	0 ~ 40°C, full load, after initial 1 hour warm-up		±0.02		%/°C
start-up time	time needed to reach regulation			3	s
hold-up time	at 115 V ac, full load	10			ms
output power limit	primary power limited				
overload protection	Fold-back current limiting starts at 105 ~ 160% of the rated output current. Auto-recovery. Long term exposure to overload condition may reduce product reliability.				
short circuit protection	Continuous, auto-recovery upon removal of short				

## SAFETY & EMI

parameter	conditions/description	min	nom	max	units
HI-POT	input to output at 10 mA for 1 second			3000	V ac
insulation resistance	input to output at 500 V dc	100			MΩ
safety approvals	UL/cUL 1310				
EMI standard	FCC part 15 class B				
leakage current	at 120 V ac			0.5	mA
RoHS compliant	yes				
class 2 power supply	yes				

## ENVIRONMENTAL

parameter	conditions/description	min	nom	max	units
operating temperature		0		40	°C
operating humidity		10		90	%
storage temperature		-20		85	°C
storage humidity		10		90	%

## RELIABILITY

parameter	conditions/description	min	nom	max	units
MTBF	at 25°C, per MIL-HDBK-217E	240,000			hours



SERIES: 6 W WALL PLUG

DESCRIPTION: SWITCHING POWER SUPPLY

MECHANICAL DRAWING

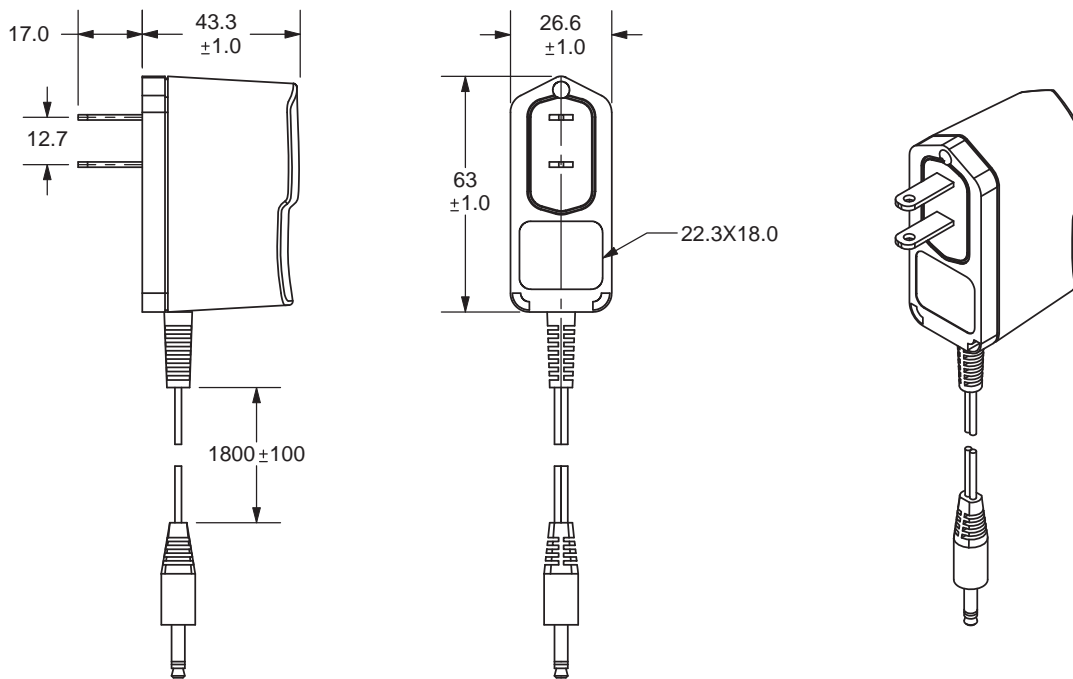

Units: mm

Tolerance:  
X.X ±0.5mm  
X.XX ±0.03mm

NOTE 1: THIS POWER UNIT IS INTENDED TO BE CORRECTLY ORIENTED IN A VERTICAL OR FLOOR MOUNT POSITION.

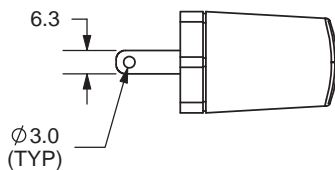



SERIES: 6 W WALL PLUG

DESCRIPTION: SWITCHING POWER SUPPLY

## OUTPUT PLUG OPTIONS

### 3.5 mm Phono Plug

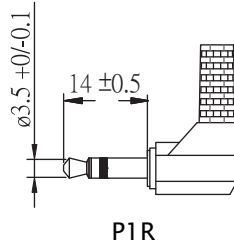
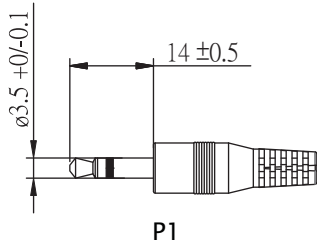

\*Tip positive

### Standard DC Plug

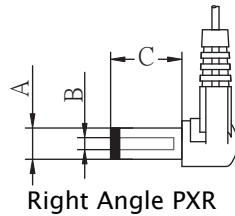
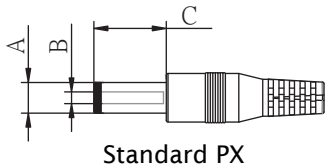

	A	B	C	Unit
P5/P5R	5.5	2.1	12	mm
P6/P6R	5.5	2.5	12	mm
P7/P7R	3.5	1.3	9.5	mm
P8/P8R	3.8	1.35	9.5	mm
P9/P9R	3.8	1.05	9.5	mm

### Locking DC Plug

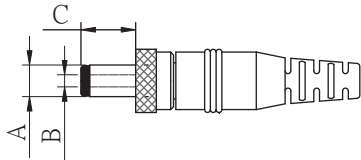

	A	B	C	Unit
P10	5.5	2.1	9.5	mm
P11	5.5	2.5	9.5	mm

### EIAJ Plugs

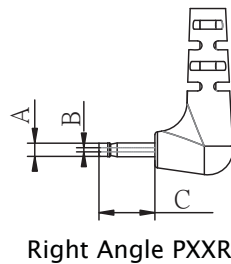
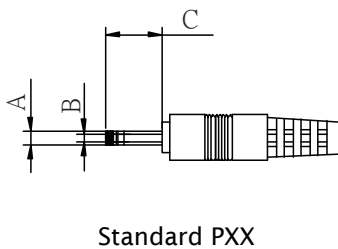

	EIAJ	A	B	C	D	Unit
P12/P12R	EIAJ-1	2.35	0.7	9.5	NA	mm
P13/P13R	EIAJ-2	4.0	1.7	9.5	5.0	mm
P14/P14R	EIAJ-3	4.75	1.7	9.5	5.0	mm

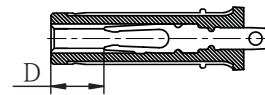

### PART NUMBER GUIDE

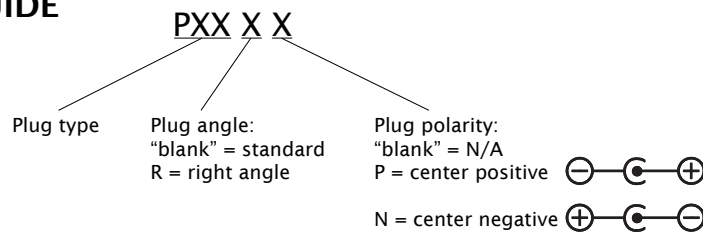

\*Contact CUI for additional output plug options.